



Vacuum Packaging Machines

Models VP-CN-0971, 1220, 1060, 1273
Items 24081, 24082, 24083, 31824

Instruction Manual



STOP
DO NOT RETURN
THIS PRODUCT TO THE STORE

For questions or assistance with this product call OMCAN Toll Free:
1 800 465 0234
Customer Service
or
visit the Support section of
www.omcan.com

Revised - 06/16/2022



Toll Free: 1-800-465-0234
Fax: 905-607-0234
Email: service@omcan.com
www.omcan.com



NEMA 5 - 15 125 VAC / 15 AMP RECEPTACLE	
NEMA 6 - 15 250 VAC / 15 AMP RECEPTACLE	

Table of Contents

Model VP-CN-0971 / Model VP-CN-1220
Model VP-CN-1060 / Model VP-CN-1273

Section	Page
General Information -----	3 - 4
Safety and Warranty -----	4 - 5
Technical Specifications -----	6
Installation -----	6
Operation -----	7
Maintenance -----	8 - 11
Troubleshooting -----	11 - 12
Parts Breakdown -----	13 - 15
Electrical Schematics -----	16
Notes -----	17 - 18
Warranty Registration -----	19



General Information

Omcan Manufacturing and Distributing Company Inc., Food Machinery of America, Inc. dba Omcan and Omcan Inc. are not responsible for any harm or injury caused due to any person's improper or negligent use of this equipment. The product shall only be operated by someone over the age of 18, of sound mind, and not under the influence of any drugs or alcohol, who has been trained in the correct operation of this machine, and is wearing authorized, proper safety clothing. Any modification to the machine voids any warranty, and may cause harm to individuals using the machine or in the vicinity of the machine while in operation.

CHECK PACKAGE UPON ARRIVAL

Upon receipt of an Omcan shipment please inspect for external damage. If no damage is evident on the external packaging, open carton to ensure all ordered items are within the box, and there is no concealed damage to the machine. If the package has suffered rough handling, bumps or damage (visible or concealed), please note it on the bill of lading before accepting the delivery and contact Omcan within 24 hours, so we may initiate a claim with the carrier. A detailed report on the extent of the damage caused to the machine must be filled out within three days, from the delivery date shown in the shipping documents. Omcan has no recourse for damaged products that were shipped collect or third party.

Before operating any equipment, always read and familiarize yourself with all operation and safety instructions.

Omcan would like to thank you for purchasing this machine. It's of the utmost importance to save these instructions for future reference. Also save the original box and packaging for shipping the equipment if servicing or returning of the machine is required.

Omcan Fabrication et distribution Compañie Limité et Food Machinery d'Amérique, dba Omcan et Omcan Inc. ne sont pas responsables de tout dommage ou blessure causé du fait que toute personne ait utilisé cet équipement de façon irrégulière. Le produit ne doit être exploité que par quelqu'un de plus de 18 ans, saine d'esprit, et pas sous l'influence d'une drogue ou d'alcool, qui a été formé pour utiliser cette machine correctement, et est vêtu de vêtements de sécurité approprié. Toute modification de la machine annule toute garantie, et peut causer un préjudice à des personnes utilisant la machine ou des personnes à proximité de la machine pendant son fonctionnement.

VÉRIFIEZ LE COLIS DÈS RÉCEPTION

Dès réception d'une expédition d'Omcan veuillez inspecter pour dommages externes. Si aucun dommage n'est visible sur l'emballage externe, ouvrez le carton afin de s'assurer que tous les éléments commandés sont dans la boîte, et il n'y a aucun dommage dissimulé à la machine. Si le colis n'a subi aucune mauvaises manipulations, de bosses ou de dommages (visible ou cachée), notez-le sur le bond de livraison avant d'accepter la livraison et contactez Omcan dans les 24 heures qui suivent, pour que nous puissions engager une réclamation auprès du transporteur. Un rapport détaillé sur l'étendue des dommages causés à la machine doit être rempli dans un délai de trois jours, à compter de la date de livraison indiquée dans les documents d'expédition. Omcan n'a aucun droit de recours pour les produits endommagés qui ont été expédiés ou cueilli par un tiers transporteur.

General Information

Avant d'utiliser n'importe quel équipement, toujours lire et vous familiariser avec toutes les opérations et les consignes de sécurité.

Omcan voudrais vous remercier d'avoir choisi cette machine. Il est primordial de conserver ces instructions pour une référence ultérieure. Également conservez la boîte originale et l'emballage pour l'expédition de l'équipement si l'entretien ou le retour de la machine est nécessaire.

Omcan Empresa De Fabricacion Y Distribucion Inc. Y Maquinaria De Alimentos De America, Inc. dba Omcan y Omcan Inc. no son responsables de ningun daño o perjuicio causado por cualquier persona inadecuada o el uso descuidado de este equipo. El producto solo podra ser operado por una persona mayor de 18 años, en su sano juicio y no bajo alguna influencia de droga o alcohol, y que este ha sido entrenado en el correcto funcionamiento de esta máquina, y ésta usando ropa apropiada y autorizada. Cualquier modificación a la máquina anula la garantía y puede causar daños a las personas usando la máquina mientras esta en el funcionamiento.

REVISE EL PAQUETE A SU LLEGADA

Tras la recepcion de un envio Omcan favor inspeccionar daños externos. Si no hay daños evidentes en el empaque exterior, Habra el carton para asegurarse que todos los articulos solicitados estén dentro de la caja y no encuentre daños ocultos en la máquina. Si el paquete ha sufrido un manejo de poco cuidado, golpes o daños (visible o oculto) por favor anote en la factura antes de aceptar la entrega y contacte Omcan dentro de las 24 horas, de modo que podamos iniciar una reclamación con la compañía. Un informe detallado sobre los daños causados a la máquina debe ser llenado en el plazo de tres días, desde la fecha de entrega que se muestra en los documentos de envío. Omcan no tiene ningun recurso por productos dañados que se enviaron a recoger por terceros.

Antes de utilizar cualquier equipo, siempre lea y familiarizarse con todas las instrucciones de funcionamiento y seguridad.

Omcan le gustaría darle las gracias por la compra de esta máquina. Es de la mayor importancia para salvar estas instrucciones para futuras consultas. Además, guarda la caja original y el embalaje para el envío del equipo si servicio técnico o devolución de la máquina que se requiere.

Safety and Warranty

1. Before operation, please read through the user guide about each operation rules and safety precaution.
2. You must fill the vacuum pump with pump oil before use (when the machine is placed at a horizontal position, the oil should keep at 1/3-1/2 of the oil window). When running, the oil level should not be lower than 1/3 of the oil window. Do not fill with too much oil to avoid over flow.
3. The machine should be placed horizontally in good ventilation and light without corrosive gas and heavy dust.
4. The power connection position may be located on a different side, be sure that there is proper grounding

Safety and Warranty

protection before use.

5. Always ensure top cover is open before turning the power on. Start the machine by pressing the top cover and the process start automatically. For 3-Phase units, please be sure the vacuum pump is running in the correct direction. If the direction is wrong, simply switch the phase of the power.
6. Preheat of vacuum pump must be done in low temperature working area. Turn off the heater selection switch at the control panel to off position. This is to prevent heating process and cut down wear and tear losses.

Note: Do not block the air hole in the chamber.

RESIDENTIAL USERS: Vendor assumes no liability for parts or labor coverage for component failure or other damages resulting from installation in non-commercial or residential applications. The right is reserved to deny shipment for residential usage; if this occurs, you will be notified as soon as possible.

1 YEAR PARTS AND LABOUR WARRANTY

Within the warranty period, contact Omcan Inc. at 1-800-465-0234 to schedule an Omcan authorized service technician to repair the equipment locally.

Unauthorized maintenance will void the warranty. Warranty covers electrical and part failures, not improper use.

Please see <https://omcan.com/disclaimer> for complete info.

WARNING:

The packaging components are classified as normal solid urban waste and can therefore be disposed of without difficulty.

In any case, for suitable recycling, we suggest disposing of the products separately (differentiated waste) according to the current norms.

DO NOT DISCARD ANY PACKAGING MATERIALS IN THE ENVIRONMENT!

Technical Specifications

Model	VP-CN-0971	VP-CN-1220	VP-CN-1060	VP-CN-1273
Description	Double Seal Bar	Single Seal Bar		Double Seal Bar
Seal Bar	16.5" x 0.3" 420 x 8mm (2x)	15.7" x 0.3" 400 x 8mm		20.5" x 0.3" 520 x 8mm (2x)
Cycle Time	23 seconds	26 seconds	25 seconds	28 seconds
Pump Power	20 m ³ /h			45 m ³ /h
Power	0.9 kW / 1.2 HP			1.1 kW / 1.4 HP
Chamber Size	17.3" x 16.5" x 5" 440 x 420 x 130mm	23" x 16.5" x 8.3" 580 x 420 x 210mm	17" x 16.5" x 8" 430 x 420 x 200mm	21.3" x 20.5" x 8.3" 540 x 520 x 210mm
Electrical	220V / 60Hz / 1	110V / 60Hz / 1		220V / 60Hz / 3
Weight	176 lbs. / 79.8 kgs.	200.8 lbs. / 91 kgs.	187 lbs. / 84.8 kgs.	253 lbs. / 114.8 kgs.
Dimensions	22" x 18.7" x 39" 560 x 470 x 990mm	28.5" x 19" x 38" 720 x 480 x 970mm	22" x 18.7" x 41" 56 x 475 x 1040mm	26.8" x 23.2" x 37.8" 680 x 590 x 960mm
Item Number	24081	24082	24083	31824

Installation

Please set every parameter before starting the machine.

1. Turn on the power supply, check through the settings on the panel and make sure "--" must be show after setting is done, otherwise operation of this machine cannot be conducted.
2. Press the setting button, the indicator lamp of vacuum lights to enter into the setting state of vacuum timing. Press the upward or downward key to increase or decrease vacuum time in the range of 0-99 seconds.
3. Press the setting button, sealing indicator lamp lights to enter the sealing setting state. Press the upward or downward key to increase or decrease sealing time in the range of 0-3.5 seconds.
4. Press the setting button, cooling indicator lamp lights to enter the cooling setting state. Press the upward or downward key to increase or decrease cooling time in the range of 0-9.9 seconds.
5. After the cooling time is set, press the setting button to finish parameter setting and "ED" is shown on the panel.
6. Press the sealing temperature button, temperature indicator lamp lights to enter the temperature setting state. You may choose between high temperature, middle temperature and low temperature.

NEW TYPE INSTRUCTIONS

Turn on the power supply, long press the “SET” to enter the memory function, there will “P0” to “P9” showed on the screen which means enter the memory setting mode, each time the “SET” is pressed which means to switch the preset parameter template, select P0 parameter template long press the “SET” to enter the P0 parameter template, press the “SEALING TEMPERATURE” to switch the sealing temperature, after that press the “SET” to set the vacuum, sealing and cooling time. Press the “SET” to return to the standby state. The complete process of parameter preset.

OLD TYPE INSTRUCTIONS

1. Turn on the power supply and select a suitable vacuum packaging bag for the product.
2. Set the processing parameter and select the sealing temperature, see installation.
3. Place the vacuum bag in the chamber with the opening end on top of the sealing bar. Clamp it with pressing stick.
4. Close the acrylic cover and the machine will complete the procedure automatically.
5. During processing, the vacuum chamber will form a vacuum self-lock state, the whole heating and sealing procedure are completed in a vacuum environment and the LED display shows the flow process.
6. When the vacuum indicator on the panel lights, the equipment is under vacuum state, the LED display shows the vacuum time and will automatically enter the next work state when the time completes.
7. When the sealing indicator on the panel lights, the equipment is under sealing state, the LED display shows the sealing time and will automatically enter the next work state when the time completes.
8. According to the time setting, the machine doesn't act when cooling, the panel shows “□□” till the timing is finished, air is returned, the cover opens automatically, and the whole process is finished. Then prepare the next cycle.

Note: Press the E-Stop button in the event of unexpected issue during operation.

NOTE

- Disconnect from power supply when not in use.
- Do not run machine without vacuum bags.

IMPORTANT INFORMATION ABOUT COOLING: THE COOLING TIME MUST BE SET AT LEAST 1 SECOND LONGER THAN THE SEALING TIME, FAILURE TO DO SO MAY RESULT IN A FIRE.

Maintenance

FILLING THE OIL

Remove the rear board and unscrew the bottom board to drain the old oil. Once drained, screw the bottom board back then unscrew the oil filling section, use a bottle to fill with the new oil and screw closed. See the below examples of locations for the oil tank.

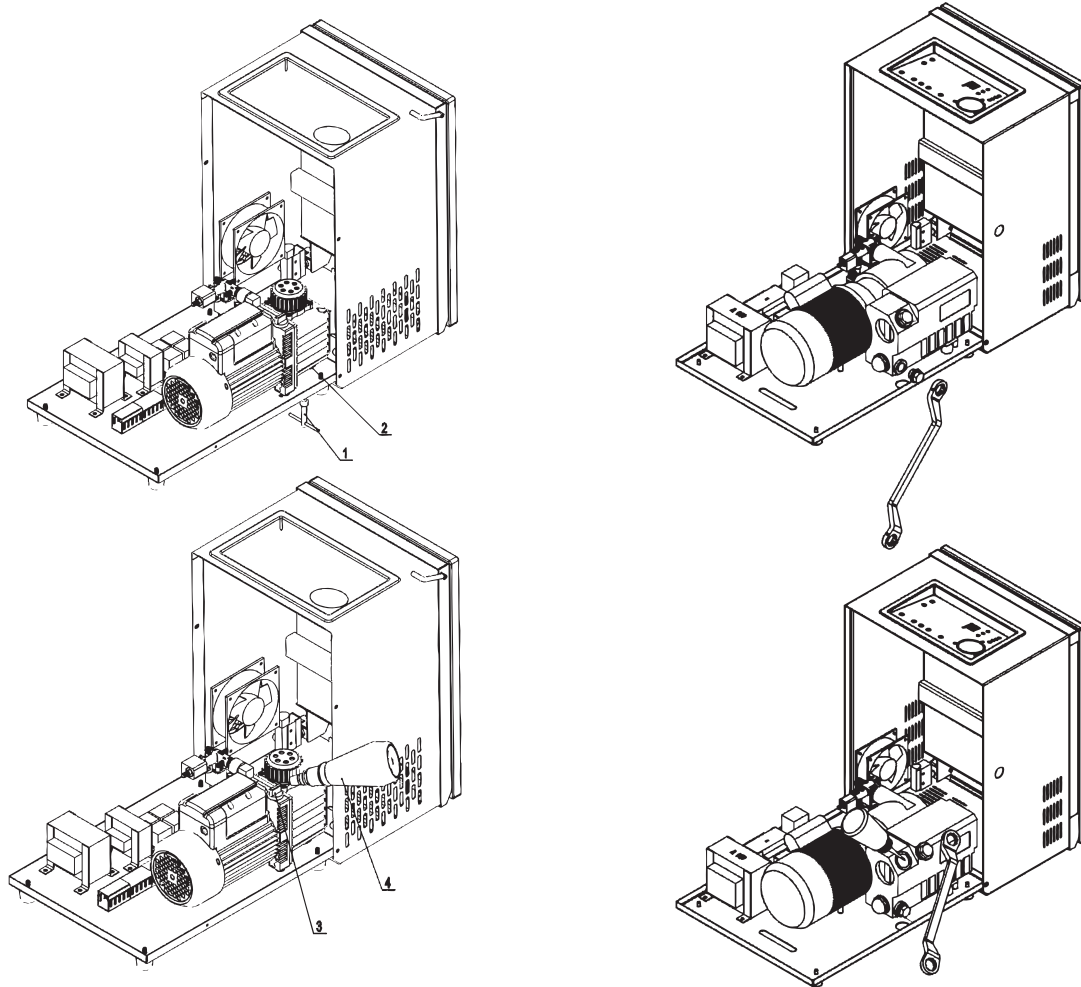

NOTE: FILL WITH NEW FOOD GRADE OIL.

REPLACING THE SEALING TAPE AND HEATING WIRE

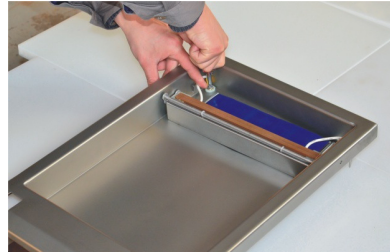

1. Disconnect the cable from the pin, then pick the complete sealing bar up from the vacuum chamber.

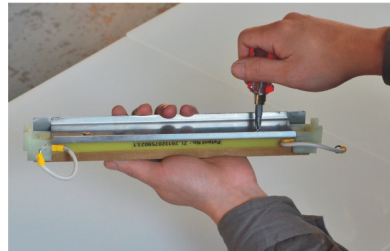
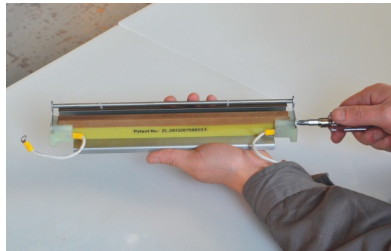

2. Remove the pressing stick from the complete sealing bar by cross screwdriver, then remove the stainless steel base.

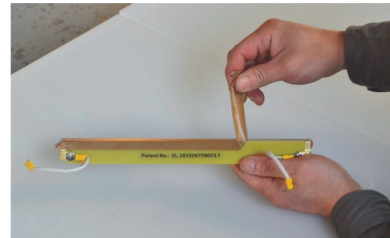

3. Pull the plastic parts out from the two sides of the sealing bar by hand, then tear off the sealing tape.

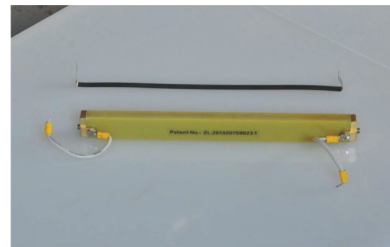

4. Remove the forcing screws from the two sides of the sealing bar with an Allen Key, then remove the heating wire.

Maintenance

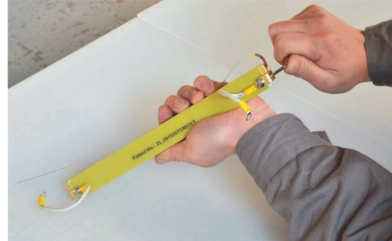
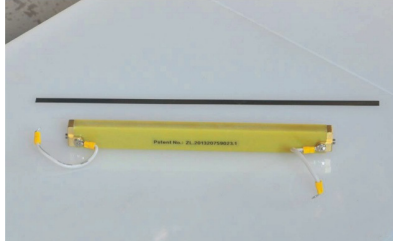

5. Put one side of a new heating wire into the fastener groove and tighten it with the Allen Key.

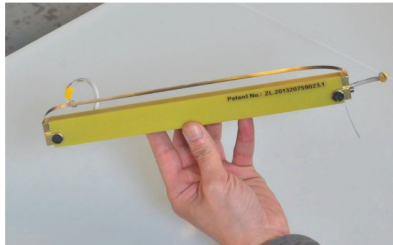

6. Put the other side of the heating wire into the other side fastener groove, then screw it with the Allen Key.

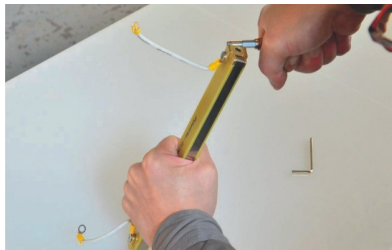
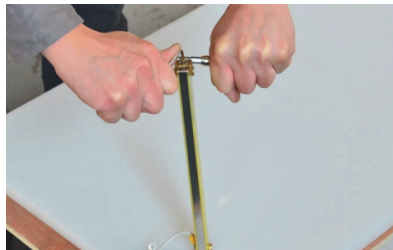

7. Fasten the heating wire, then cut the excess heating wire.

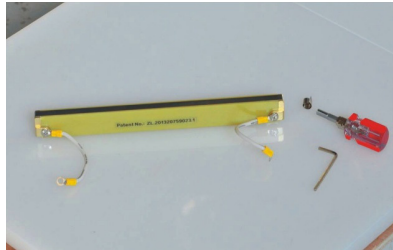

8. Take the new sealing tape at a proper length and stick it on the heating wire.

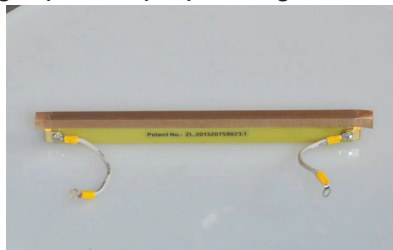

9. Cut the remaining sealing tape on the ends to allow them to fold over.

Maintenance



10. Put plastic clamps on the sides of the sealing bar.

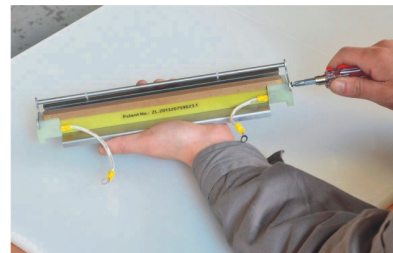
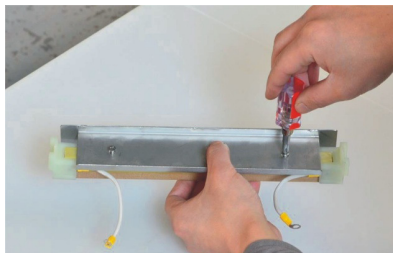

11. Install the stainless steel base and pressing stick.



12. Connect the cable of the complete sealing bar to the pin, then put the sealing bar back in the vacuum chamber to complete the installation.

Troubleshooting

Problem	Cause	Solution
Vacuum pump does not work.	Limit switch is not pressed on.	Close the machine cover and adjust the limit switch.
	Limit switch is broken.	Replace.
	Contactors is broken.	Replace.
	Pump motor is broken.	Replace.

Troubleshooting

Vacuum chamber cannot reach the vacuum degree.	The vacuum pump is worn or damaged.	Replace.
	Loose air pipe joint, broken pip, damaged sealing ring of vacuum chamber or damaged valve.	Tighten or replace.
	Insufficient oil in vacuum pump.	Add more oil.
	Vacuum time is not enough.	Increase the vacuum time.
Cover cannot be opened.	Air release valve is not turned on.	Turn on the air release valve.
Air remains in bag after operation is finished.	Wrong position resting on sealing bar.	Reposition.
	Pressing stick presses the bag open.	Replace the pressing stick.
Abnormal sound or tripping when running, black smoke or oil drop.	Abnormal sound of fan of pump motor.	Call Omcan.
	Blockage in air intake and/or pip.	Unblock.
	Insufficient oil, or non standard oil used.	Add more oil, or replace with food grade oil.
	Overheating of pump.	Lessen the operating time.
	Faulty vacuum pump motor or valve of vacuum pump.	Replace.
Not able to seal.	The temperature is not selected.	Select the temperature.
	The heating wire is damaged or connecting wire is cut off.	Replace the wire or reconnect.
	The sealing time is at 0.	Increase the sealing time.
	The relay is damaged.	Replace the relay.
	The sealing valve does not operate.	Call Omcan.
Uneven sealing veins, air bubbles, or not sealing properly.	Silicon sealer is dirty.	Clean the sealer.
	Sealing time is too short.	Increase sealing time.
	Temperature is too low.	Increase the temperature.
	Cooling time insufficient.	Increase the cooling time.
	Sealing tape is damaged.	Replace the sealing tape.

Parts Breakdown

Model VP-CN-0971 24081

Model VP-CN-1220 24082

Model VP-CN-1060 24083

Model VP-CN-1273 31824

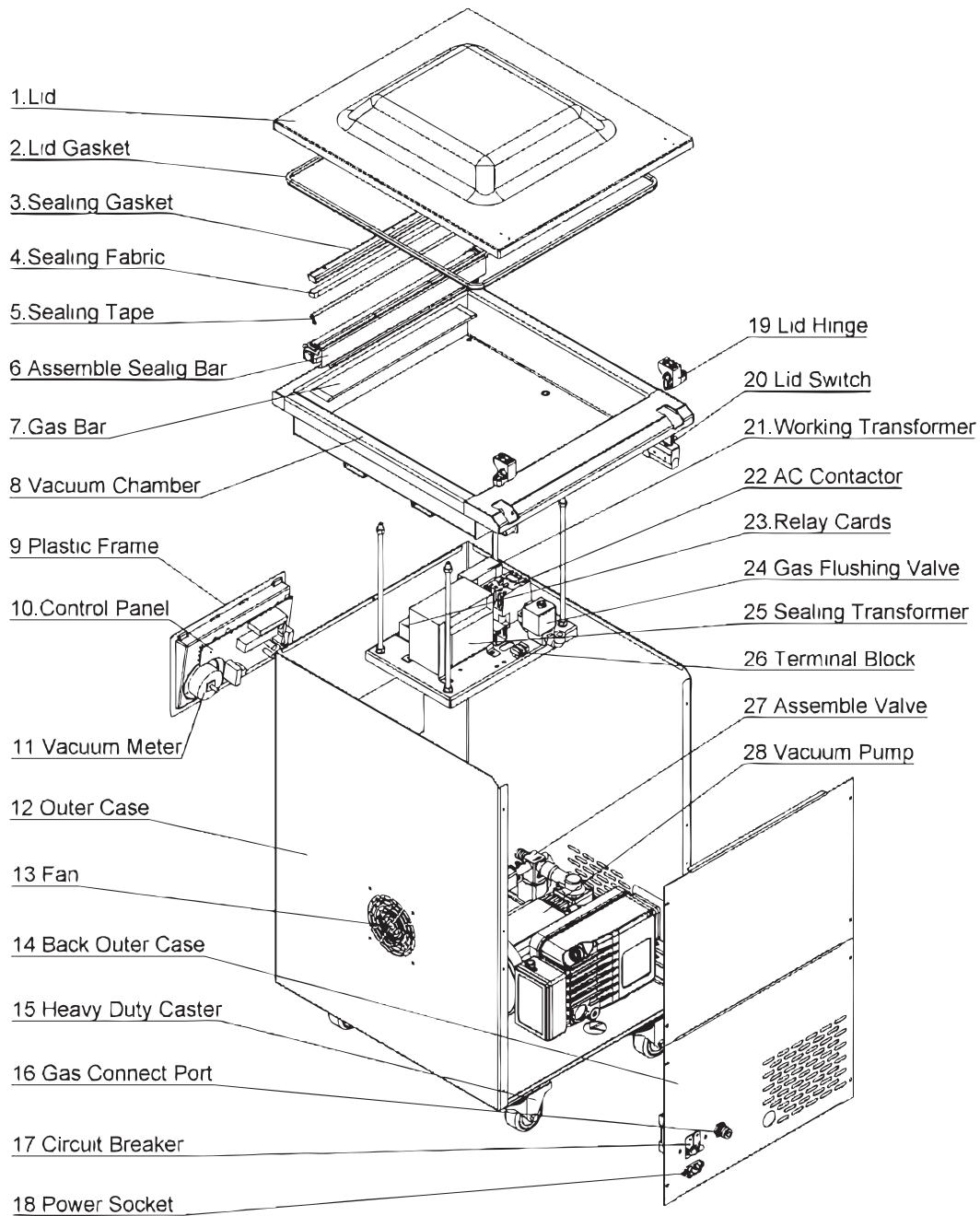

Parts Breakdown

Model VP-CN-0971 24081

Item No.	Description	Position	Item No.	Description	Position	Item No.	Description	Position
AE448	Lid for 24081	1	AE454	Vacuum Meter for 24081	11	AE466	Gas Flushing Valve for 24081	24
AE449	Lid Gasket for 24081	2	AE462	Fan for 24081	13	AE470	Sealing Transformer for 24081	25
AE450	Sealing Gasket for 24081	3	AE463	Gas Connect Port for 24081	16	AE458	Assemble Valve for 24081	27
AE451	Sealing Fabric (10m/Roll) for 24081	4	AE467	Circuit Breaker for 24081	17	AE459	Vacuum Pump for 24081	28
AE452	Sealing Wire for 24081	5	AE464	Power Socket for 24081	18	AE457	Filter for 24081	
AE156	Assemble Sealing Bar for 24081	6	AE460	Lid Hinge for 24081	19	AE465	Power Switch for 24081	
AE453	Gas Bag for 24081	7	AE461	Lid Switch for 24081	20	AE471	PP Plate for 24081	
AE455	Plastic Frame for 24081	9	AE469	Working Transformer for 24081	21	AG793	Power Cord for 24081	
AE456	Control Panel for 24081	10	AE468	Relay Cards for 24081	23			

Model VP-CN-1220 24082

Item No.	Description	Position	Item No.	Description	Position	Item No.	Description	Position
AE472	Lid for 24082	1	AE479	Vacuum Meter for 24082	11	AE491	Gas Flushing Valve for 24082	24
AE473	Lid Gasket for 24082	2	AE487	Fan for 24082	13	AE495	Sealing Transformer for 24082	25
AE474	Sealing Gasket for 24082	3	AE488	Gas Connect Port for 24082	16	AE483	Assemble Valve for 24082	27
AE475	Sealing Fabric (10M/Roll) for 24082	4	AE492	Circuit Breaker for 24082	17	AE484	Vacuum Pump for 24082	28
AE476	Sealing Tape for 24082	5	AE489	Power Socket for 24082	18	AE482	Filter for 24082	
AE477	Assemble Sealing Bar for 24082	6	AE485	Lid Hinge for 24082	19	AE490	Power Switch for 24082	
AE478	Gas Bag for 24082	7	AE486	Lid Switch for 24082	20	AE496	PP Plate for 24082	
AE480	Plastic Frame for 24082	9	AE494	Working Transformer for 24082	21	AG794	Power Cord for 24082	
AE481	Control Panel for 24082	10	AE493	Relay Cards for 24082	23			

Parts Breakdown

Model VP-CN-1060 24083

Item No.	Description	Position	Item No.	Description	Position	Item No.	Description	Position
AE497	Lid for 24083	1	AE504	Vacuum Meter for 24083	11	AE516	Gas Flushing Valve for 24083	24
AE498	Lid Gasket for 24083	2	AE512	Fan for 24083	13	AE520	Sealing Transformer for 24083	25
AE499	Sealing Gasket for 24083	3	AE513	Gas Connect Port for 24083	16	AE508	Assemble Valve for 24083	27
AE500	Sealing Fabric (10M/Roll) for 24083	4	AE517	Circuit Breaker for 24083	17	AE509	Vacuum Pump for 24083	28
AE501	Sealing Tape per/Meter for 24083	5	AE514	Power Socket for 24083	18	AE507	Filter for 24083	
AE502	Assemble Sealing Bar for 24083	6	AE510	Lid Hinge for 24083	19	AE515	Power Switch for 24083	
AE503	Gas Bag for 24083	7	AE511	Lid Switch for 24083	20	AE521	PP Plate for 24083	
AE505	Plastic Frame for 24083	9	AE519	Working Transformer for 24083	21	AG795	Power Cord for 24083	
AE506	Control Panel for 24083	10	AE518	Relay Cards for 24083	23			

Model VP-CN-1273 31824

Item No.	Description	Position	Item No.	Description	Position	Item No.	Description	Position
AE522	Lid for 31824	1	AE528	Vacuum Meter for 31824	11	AE540	Gas Flushing Valve for 31824	24
AE523	Lid Gasket for 31824	2	AE536	Fan for 31824	13	AE544	Sealing Transformer for 31824	25
AE524	Sealing Gasket for 31824	3	AE537	Gas Connect Port for 31824	16	AE532	Assemble Valve for 31824	27
AE525	Sealing Fabric (10m/Roll) for 31824	4	AE541	Circuit Breaker for 31824	17	AE533	Vacuum Pump for 31824	28
AE526	Sealing Tape for 31824	5	AE538	Power Socket for 31824	18	AE531	Filter for 31824	
AC190	Complete Sealing Bar for 31824	6	AE534	Lid Hinge for 31824	19	AE539	Power Switch for 31824	
AE527	Gas Bag for 31824	7	AE535	Lid Switch for 31824	20	AE545	PP Plate for 31824	
AE529	Plastic Frame for 31824	9	AE543	Working Transformer for 31824	21	AG796	Power Cord for 31824	
AE530	Control Panel for 31824	10	AE542	Relay Cards for 31824	23			

Electrical Schematics

Model VP-CN-0971 24081

Model VP-CN-1220 24082

Model VP-CN-1060 24083

Model VP-CN-1273 31824

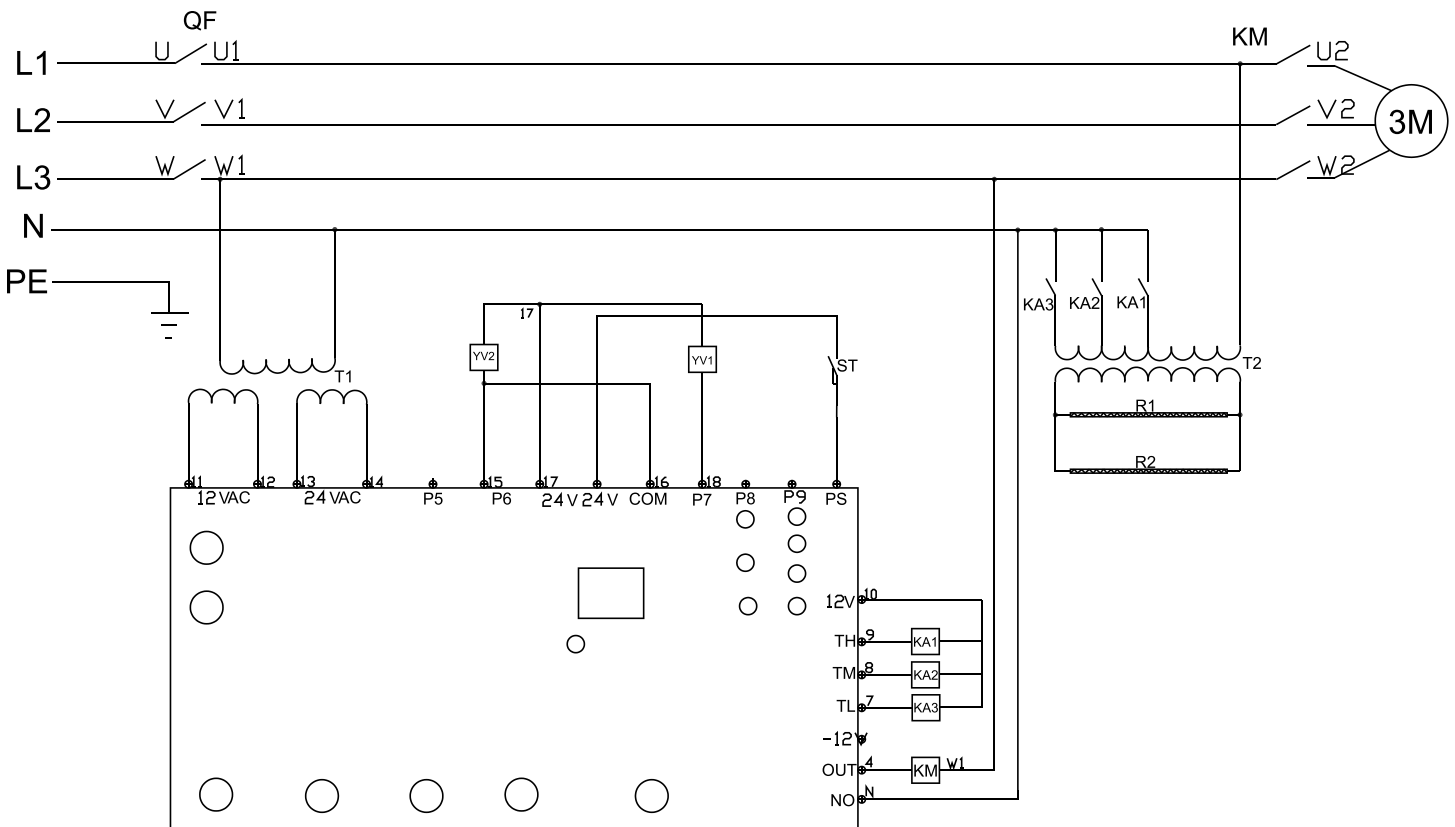



Warranty Registration

Thank you for purchasing an Omcan product. To register your warranty for this product, complete the information below, tear off the card at the perforation and then send to the address specified below. You can also register online by visiting:

Merci d'avoir acheté un produit Omcan. Pour enregistrer votre garantie pour ce produit, complétez les informations ci-dessous, détachez la carte au niveau de la perforation, puis l'envoyer à l'adresse spécifiée ci-dessous. Vous pouvez également vous inscrire en ligne en visitant:

Gracias por comprar un producto Omcan usted. Para registrar su garantía para este producto, complete la información a continuación, cortar la tarjeta en la perforación y luego enviarlo a la dirección indicada a continuación. También puede registrarse en línea en:

<https://omcan.com/warranty-registration/>

For mailing in Canada

Pour postale au Canada

Por correo en Canadá

OMCAN

PRODUCT WARRANTY REGISTRATION

3115 Pepper Mill Court,

Mississauga, Ontario

Canada, L5L 4X5

For mailing in the US

Pour diffusion aux États-Unis

Por correo en los EE.UU.

OMCAN

PRODUCT WARRANTY REGISTRATION

4450 Witmer Industrial Estates, Unit 4,

Niagara Falls, New York

USA, 14305

or email to: service@omcan.com



Purchaser's Information

Name: _____

Address: _____

City: _____ Province or State: _____ Postal or Zip: _____

Country: _____

Dealer from which Purchased: _____

Dealer City: _____ Dealer Province or State: _____

Invoice: _____

Model Name: _____ Model Number: _____

Machine Description: _____

Date of Purchase (MM/DD/YYYY): _____

Would you like to extend the warranty? Yes No

Company Name: _____

Telephone: _____

Email Address: _____

Type of Company:

Restaurant Bakery Deli

Butcher Supermarket Caterer

Institution (*specify*): _____

Other (*specify*): _____

Serial Number: _____

Date of Installation (MM/DD/YYYY): _____

Thank you for choosing Omcan | Merci d'avoir choisi Omcan | Gracias por elegir Omcan



Since 1951 Omcan has grown to become a leading distributor of equipment and supplies to the North American food service industry. Our success over these many years can be attributed to our commitment to strengthen and develop new and existing relationships with our valued customers and manufacturers. Today with partners in North America, Europe, Asia and South America, we continually work to improve and grow the company. We strive to offer customers exceptional value through our qualified local sales and service representatives who provide convenient access to over 6,500 globally sourced products.

Depuis 1951 Omcan a grandi pour devenir un des “leaders” de la distribution des équipements et matériel pour l’industrie des services alimentaires en Amérique du Nord. Notre succès au cours de ces nombreuses années peut être attribué à notre engagement à renforcer et à développer de nouvelles et existantes relations avec nos clients et les fabricants de valeur. Aujourd’hui avec des partenaires en Amérique du Nord, Europe, Asie et Amérique du Sud, nous travaillons continuellement à améliorer et développer l’entreprise. Nous nous efforçons d’offrir à nos clients une valeur exceptionnelle grâce à nos ventes locales qualifiées et des représentants de service qui offrent un accès facile à plus de 6500 produits provenant du monde entier.

Desde 1951 Omcan ha crecido hasta convertirse en un líder en la distribución de equipos y suministros de alimentos en América del Norte industria de servicios. Nuestro éxito en estos años se puede atribuir a nuestro compromiso de fortalecer y desarrollar nuevas relaciones existentes con nuestros valiosos clientes y fabricantes. Hoy con socios de América del Norte, Europa, Asia y América del Sur, que trabajan continuamente para mejorar y crecer la empresa. Nos esforzamos por ofrecer a nuestros clientes valor excepcional a través de nuestro local de ventas y representantes de los servicios que proporcionan un fácil acceso a más de 6,500 productos con origen a nivel mundial.

